

Aplicatia 2

Sa se determine reactiunile interioare si exterioare pentru cadrul din figura.

n=1...6

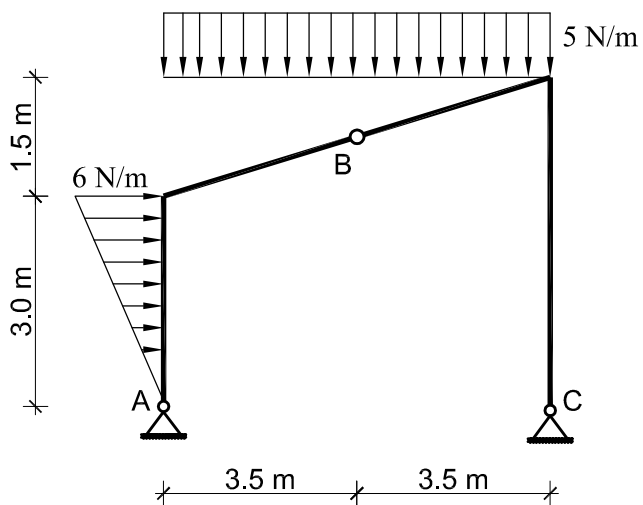

n=19...24

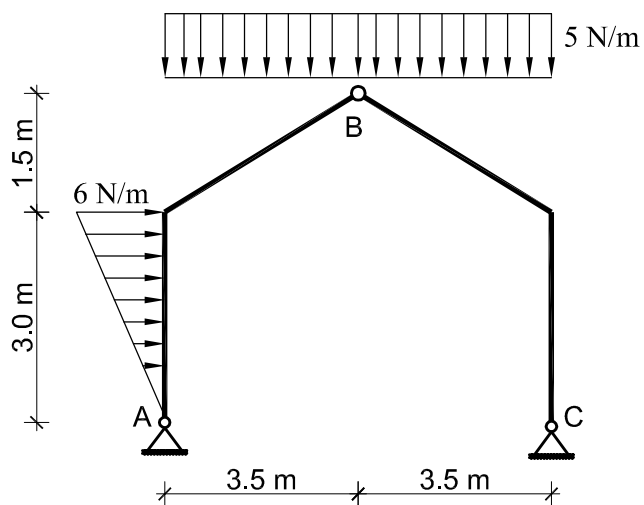

n=7...12

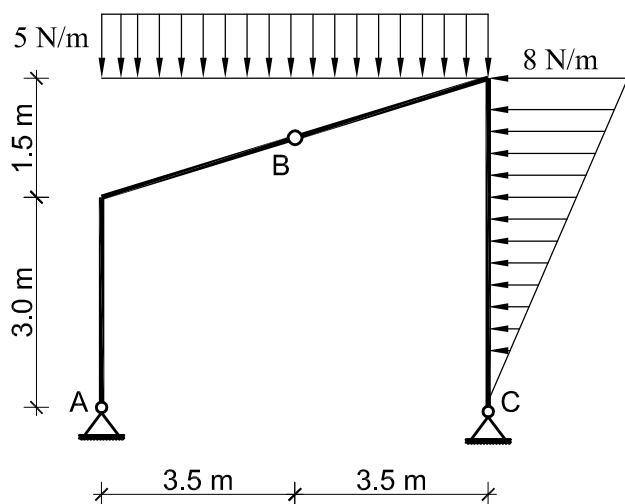

n=25...30

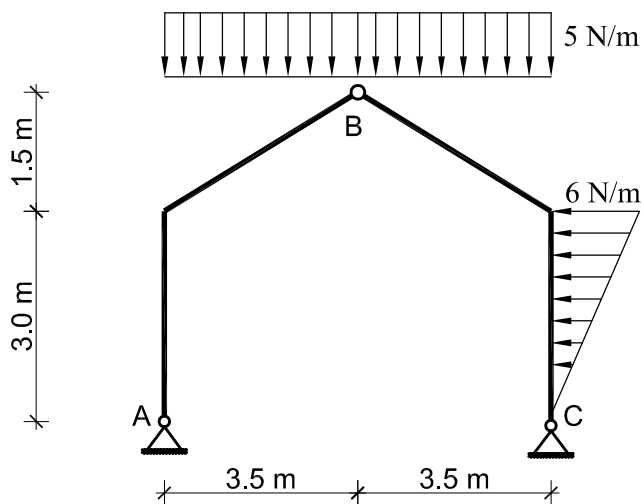

n=13...18

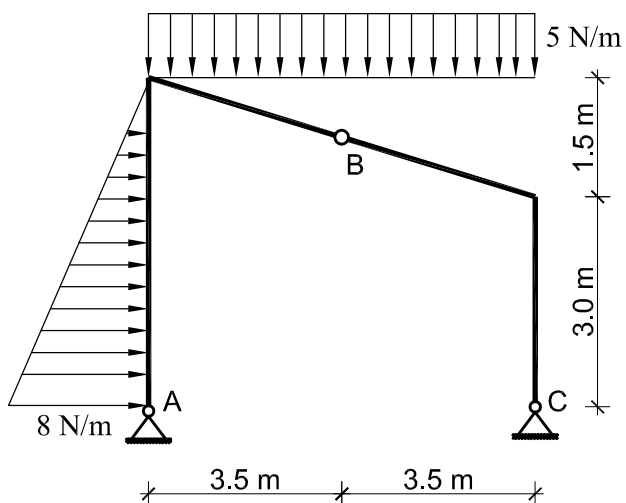

n=31...36

